



# CORiTEC 150i series

# The CORiTEC 150i series

## WHAT ARE THE DIFFERENCES?

	CORTEC 150i PRO	CORTEC 150i dry	CORTEC 150i dry eco
PC	integrated	integrated	external PC required
Touchscreen	✓	✓	-
Integrated PC	✓	✓	-
Premilled Abutments	✓ (CoCr/Ti)	✓ (CoCr)	✓ (CoCr)
Wet processing	✓	-	-
Dry processing	✓	✓	✓
Metal processing**	✓	✓	✓
Integrated water tank	✓	-	-
Ionizer	✓	✓	optional
Auto calibration*	✓	✓	✓
Chip tray	-	✓	optional
98mm blank holder	✓	✓	✓
6-fold glass ceramic holder	optional	-	-



# The new features...



Minimum compressed air requirement



Integrated ionizer



Auto calibration\*



Automated cleaning function\*



Large number of holder systems



Metal processing\*\*

WHETHER WET OR DRY MACHINING, BLOCK OR BLANK FORM, THE CORITEC 150i SERIES IMPRESSES IN ALL AREAS.

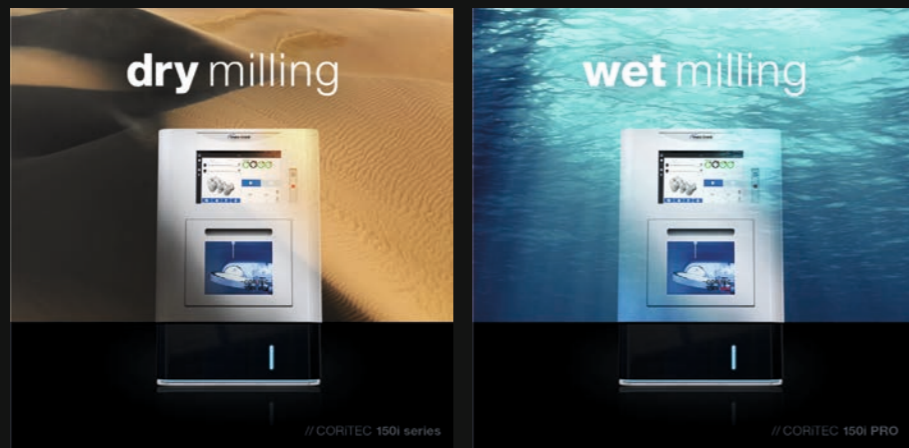

Each restoration is fabricated with optimum precision and, at the same time, the flexibility opens up an almost free choice of materials and indications. Milling and grinding of zirconium, plastics and metal\*\* is possible, as is the machining of CAD/CAM blocks and Pre-milled abutments. The CORITEC 150i offers an unrivalled variety of applications in a very small space.

UNLIMITED FLEXIBILITY IN MILLING AND GRINDING – THAT'S THE PROMISE OF THE CORITEC 150i SERIES



Thanks to a machining angle of up to 360°/130° (A-axis/B-axis), the system is able to effortlessly master even the most demanding tasks. The 10 tool places additionally increase the flexibility of the new CORITEC 150i series.

\*In preparation | \*\*Limited metal processing in preparation



# The new features...

MORE PERFORMANCE,  
MAXIMUM FLEXIBILITY AND  
EXTENDED APPLICATION  
POSSIBILITIES WITH MINIMAL  
SPACE REQUIREMENTS

An exceptional ratio of power, speed and precision – this is what the powerful high-frequency spindle with 750 W and 100.000 rpm offers. Thanks to the quick-clamping system, the various holder systems can be changed quickly and easily – while maintaining the same precision. Time-consuming calibrations are therefore unnecessary.



A VARIETY OF  
HOLDING SYSTEMS  
OFFERS MAXIMUM  
FLEXIBILITY FOR  
MAXIMUM CHALLENGES

Also new is the support of the half-open blank holder, the so-called "C-Clamp". Thanks to its open shape, it allows even the most difficult indications to be produced.

**NEW  
FEATURES**



# CORiTEC 150i PRO

## THE FLEXIBLE MILLING SYSTEM IN CONFINED SPACES

The extremely stable design of the mono-block cast body enables precise machining with round blanks and block forms. The machine's small dimensions and 5-axis simultaneous technology offers a unique ratio of machine size and functionality. Convince yourself of the performance of the CORiTEC 150i for your laboratory!

Available in three versions:



CORiTEC  
150i PRO



CORiTEC  
150i dry



CORiTEC  
150i dryeco

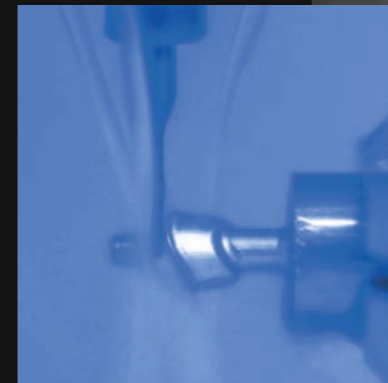

- WET
- DRY
- 5 AX
- 3mm 10x
- Temperature icon
- Touch screen icon
- Connectivity icon
- Internal view icon
- ION

# CORiTEC 150i PRO

## HIGHLIGHTS

- novel, closed mono-block cast body for highest stability and precision
- no external PC required
- half-open blank holder "C-Clamp" (optional)
- ionizer inclusive
- high precision due to integrated temperature compensation
- wet and dry machining possible
- minimum external compressed air, only 3 bar required
- short amortization period
- minimal footprint
- auto calibration\*
- automated cleaning function\*
- metal processing\*\*
- turn-milling-grinding-processing possible

\*In preparation | \*\*Limited metal processing in preparation



PMMA	WAX	Standard	PreMilled Abutment	Dentures	Crown, Bridge	Inlay, Onlay Veneer	Hybrid Abutment	Splint
Zr	COMPOSITE							
PEEK	SINT	C-Clamp	Block	Manual clamping system	Full Denture	Model	Drilling template	Model casting
Glass-ceramics	PreFab Abutments							
CoCr	Ti				Bridge	Telescopic technology	Abutment	Hybrid machining

**T1/T6 - 3.0 | 3.0 mm**  
radius milling tool (l = 15 mm)

T1	Ti
T6	CoCr

3.0 mm Ø 3 mm

up to 15 mm ↑

Blades

Art.-No. 526029 3003

**T11/T13 - 2.5 | 3.0 mm**  
radius milling tool

T11	PMMA
	WAX
T13	Zr

2.5 mm Ø 3 mm

up to 25 mm ↑

Blades

Art.-No. 526016 2503

**T16 - 1.5 | 3.0 mm**  
radius milling tool (l = 15 mm)

T16	PMMA
	WAX
	Zr

1.5 mm Ø 3 mm

up to 15 mm ↑

Blades

Art.-No. 526016 1503

**T31 - 3.0 | 3.0 mm**  
shaft milling tool (single blade, slide coated)

T31	PMMA
	WAX
	Zr

3.0 mm Ø 3 mm

up to 30 mm ↑

Blade

Art.-No. 526012 3003

**T2/T7 - 2.0 | 3.0 mm**  
radius milling tool (l = 12 mm)

T2	Ti
T7	CoCr

2.0 mm Ø 3 mm

up to 15 mm ↑

Blades

Art.-No. 526029 2003

**T12 - 1.0 | 3.0 mm**  
radius milling tool (single blade, slide coated)

T12	PMMA
	WAX
	PEEK

1.0 mm Ø 3 mm

up to 25 mm ↑

Blade

Art.-No. 526004 1003c

**T19 - 0.5 | 3.0 mm**  
shaft milling tool (l = 4 mm), universal

T19	UNIVERSAL
-----	-----------

0.5 mm Ø 3 mm

up to 15 mm ↑

Blades

Art.-No. 526001 0503

**T32 - 0.6 | 3.0 mm**  
radius milling tool long (l = 12 mm)

T32	PMMA
	WAX
	Zr

0.6 mm Ø 3 mm

up to 25 mm ↑

Blades

Art.-No. 526012 0603

**T3/T8 - 1.5 | 3.0 mm**  
radius milling tool (l = 12 mm)

T3	Ti
T8	CoCr

1.5 mm Ø 3 mm

up to 15 mm ↑

Blades

Art.-No. 526029 1503

**T12/T14 - 1.0 | 3.0 mm**  
radius milling tool

T12	PMMA
	WAX
T14	Zr

1.0 mm Ø 3 mm

up to 25 mm ↑

Blades

Art.-No. 526016 1003

**T20 - 0.6 | 3.0 mm**  
radius milling tool (conical)

T20	Ti
	CoCr

0.6 mm Ø 3 mm

up to 15 mm ↑

Blades

Art.-No. 526003 0603

**T33/T43/T53 - 0.3 | 3.0 mm**  
radius milling tool (conical)

T33	PMMA
	WAX
	Zr
T43	SINT
T53	COMP

0.3 mm Ø 3 mm

up to 25 mm ↑

Blades

Art.-No. 526016 0303

**T4/T9 - 1.0 | 3.0 mm**  
radius milling tool (l = 9 mm)

T4	Ti
T9	CoCr

1.0 mm Ø 3 mm

up to 15 mm ↑

Blades

Art.-No. 526029 1003

**T13/T40/T50 - 2.5 | 3.0 mm**  
radius milling tool (diamond coated)

T13	Zr
T40	SINT
T50	COMP

2.5 mm Ø 3 mm

up to 25 mm ↑

Blades

Art.-No. 526013 2503

**T21 - 2.5 | 3.0 mm**  
radius grinding tool (diamond)

T21	glass ceramics
-----	----------------

2.5 mm Ø 3 mm

up to 15 mm ↑

Blades

Art.-No. 526005 2503

**T98 - 2.5 | 3.0 mm**  
shaft milling tool (l = 20 mm, three blades)

T98	CALIBR.
-----	---------

2.5 mm Ø 3 mm

up to 20 mm ↑

Blades

Art.-No. 526024 2503

**T5/T10/T17 - 1.5 | 3.0 mm**  
shaft milling tool (l = 15 mm), universal

T5	Ti
T10	CoCr
T17	PMMA
	WAX
	Zr

1.5 mm Ø 3 mm

up to 25 mm ↑

Blades

Art.-No. 526001 1503

**T14/T41/T51 - 1.0 | 3.0 mm**  
radius milling tool (diamond coated)

T14	Zr
T41	SINT
T51	COMP

1.0 mm Ø 3 mm

up to 25 mm ↑

Blades

Art.-No. 526013 1003

**T22 - 1.0 | 3.0 mm**  
radius grinding tool (diamond)

T22	glass ceramics
-----	----------------

1.0 mm Ø 3 mm

up to 15 mm ↑

Blades

Art.-No. 526005 1003

**T11 - 2.5 | 3.0 mm**  
radius milling tool (single blade, slide coated)

T11	PMMA
	WAX
	PEEK

2.5 mm Ø 3 mm

up to 25 mm ↑

Blade

Art.-No. 526004 2503c

**T15/T42/T52 - 0.6 | 3.0 mm**  
radius milling tool (conical)

T15	PMMA
	WAX
	Zr
T42	SINT
T52	COMP

0.6 mm Ø 3 mm

up to 25 mm ↑

Blades

Art.-No. 526016 0603

**T23 - 0.6 | 3.0 mm**  
radius grinding tool (conical, diamond)

T23	glass ceramics
-----	----------------

0.6 mm Ø 3 mm

up to 15 mm ↑

Blades

Art.-No. 526005 0603

# CORiTEC Materials

## CORiTEC ZR (ZIRCONIUM DIOXIDE)

Covers all indications for dental restorations of up to 16 units. Ideally suited for monolithic restorations.

- highly translucent zirconium dioxide for natural esthetics
- increased strength compared to lithium dioxide

Zr ht+ Disc  
(highly translucent)



Zr Disc



Zr transpa Disc



Zr transpa Disc  
(pre-colored translucent)



## CORiTEC ZR (ZIRCONIUM DIOXIDE)

- single crowns
- single cap
- bridges up to 16 units, full bridges, and PFM technology
- good mechanical properties
- good milling properties
- corrosion resistant

CoCr Disc  
(non-precious alloy)



CoCr Mo Disc  
(non-precious alloy)

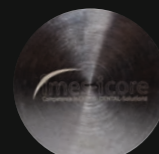

Ti Disc  
(Grad 2, Grad 4, Grad 5)



## JUVORA PEEK (POLYETHERETHERKETONE)

- clamp-retained constructions
- Juvora PEEK in its basic colour (brown-beige)
- highest biological compatibility



## CORiTEC WAX DISC (WAX, GRAY)

CORiTEC Wax Disc is not suitable for intraoral application. After milling, the material can be used as lost wax. Moulds can be used in casting technology. It can be milled easily and combusted residue-free.



## CORiTEC PMMA (POLYMETHYL METHACRYLATE)

- bite guards, therapeutic splints, drilling templates, bite regulators
- very good mechanical properties
- aesthetic shade effect due to high translucency
- good milling behaviour

PMMA Splint Disc



PMMA Disc



## CORiTEC MODEL DISC IVORY

- blank for the production of dental models
- low-cost material
- also suitable for test purposes or for milling calibration bodies





# CORiTEC SmartControl™

SMART CONTROL OF MACHINE SOFTWARE

## SmartControl™ one touch ahead!

The newly developed control software „SmartControl™“ provides absolutely intuitive operation of our milling machines. From selecting the job to milling or querying the machine status; the self-explanatory and optimized handling makes it possible to start operating the machine in the shortest possible time. Starting a milling process requires only two clicks – benefit from the smart time savings for your workflow!

## FEATURES

- Modern touch control design
- Easiest operation through intuitive graphical user interface
- High end performance for imes-icore® machines
- Remote monitoring
- Job management with 3D preview
- Multi-language support\*

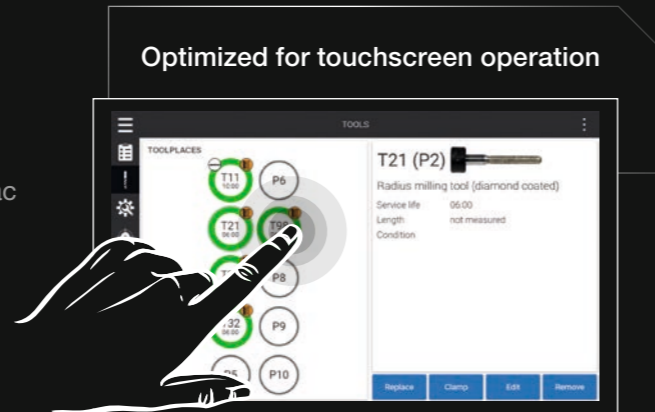

Optimized for touchscreen operation

Automated transfer of information from the CAM software



Ideal tool management

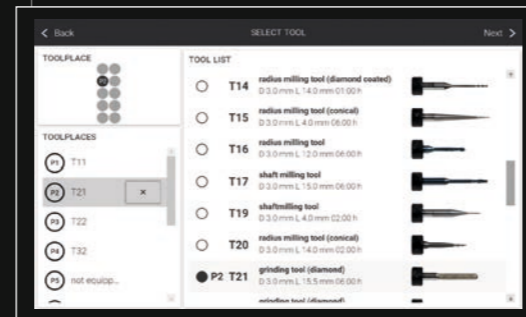

# Scanner COMPATIBLE WITH exocad

## CORiTEC i3Dscan eco

- all-round carefree package for newcomers or small laboratories
- simple, fast, low-priced
- very compact design

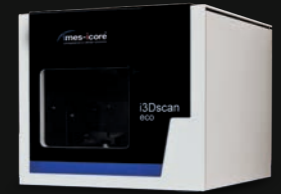

## CORiTEC i3Dscan color

- the object to be scanned is automatically guided into the measuring field
- modern touch control design
- the 180-degree opening offers a large working area



## CORiTEC i3Dscan color HR

- enormously high scanning efficiency and precision (4 µm)
- color texture scan
- Blue-Light LED & high resolution camera (2.8 MP)
- all modules included in the scope of delivery

# CAM software

## CORiTEC iCAM V5 smart

- all strategies optimized for 5-axis simultaneous machining
- automatic exchange of implant connections (ReFit option)
- no annual license fees
- fully automatic and easy operation with “Wizard Workflow“



## CORiTEC iCAM HD compact

- hyperDENT based CAM software
- flexible payment model (purchase or subscription model)
- three months free use with CORiTEC 150i machine purchase

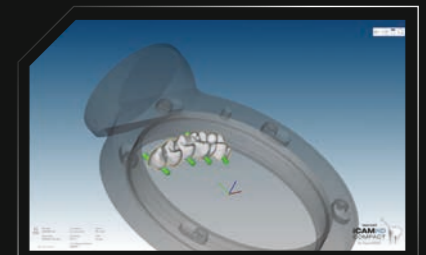

\*in preparation

# Full integrated workflow

OPEN TO ALL COMMON SCANNERS

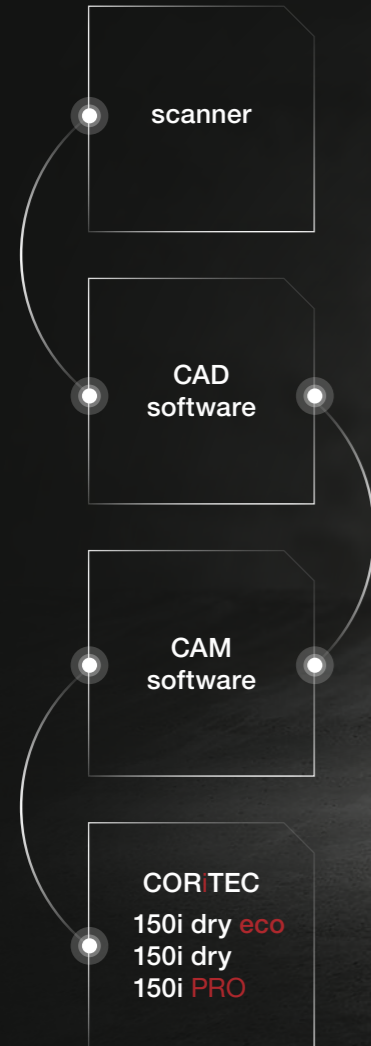

## Applications & holders

### HALF-OPEN BLANK HOLDER (C-CLAMP)

- enables 5-axis machining up to 90 degrees axis adjustment
- extension of the technical possibilities of your milling machine



### UNIVERSAL HOLDER FOR TURN-MILL-GRINDING PROCESSING

- high precision
- improved surface quality
- tool-saving machining



### PREFABRICATED ABUTMENTS

- short production times
- production of abutments in very simple processes
- high accuracy of fit due to prefabricated implant interface

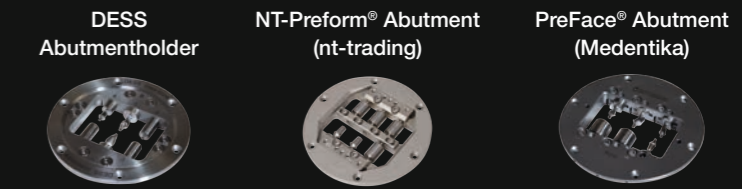

### THERAPEUTIC SPLINTS

- bite splints, bleaching splints
- snoring splints, aligners
- simple and high-quality implementation in CAD/CAM processes



### GRINDING OF CAD/CAM BLOCKS

- new 6-fold adapter enables effective production
- exchangeable strips for different adapter systems
- crowns, onlays, inlays, veneers, bridge frameworks, etc.

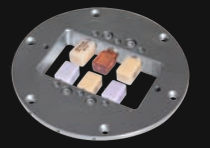

### MILLING OF MODEL CASTS

- production in combustible materials (PEEK)
- allergy-free and lightweight model casting when using PEEK
- cost-efficient

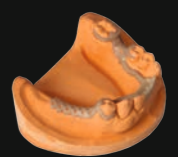

# Sintering furnaces

## iSINT eco

The **iSINT eco** stands for economy and offers high-quality technology, matching accessories for high standards at a fair price. Compact and with a small footprint, the **iSINT eco** sintering oven still has sufficient capacity for a sintering bowl Ø100 mm for approx. 25 units. The door stop can be mounted at the right or left side.

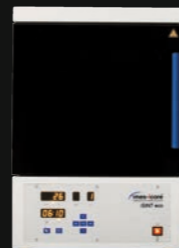

## iSINT PRO

A larger sintering capacity of up to 80 single crowns is offered by the new **iSINT PRO**. With a heating system of four high-quality molybdenum disilicide (MoSi<sub>2</sub>) heating elements, you can choose between conventional long-term sintering or SPEED sintering at a rate of up to 90 °C/min/210.20 °F/min. The **iSINT PRO** is operated with a simple and convenient program control. The programs are indicated on a 4-line LCD display. A timer function for overnight sintering or the use of pre-drying programs for shaded zirconium restorations offer further options. In addition, three service programs are available for easy maintenance of the sinter furnace.

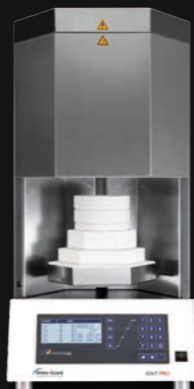

	iSINT eco	iSINT PRO
Number of heating elements	4	4
Display	7-Segment	4-line LCD
Number of program memories	9	30
Combustion chamber capacity	1 x 100	2 x 120
max. heating rate	30 °C/min / 86 °F/min	99 °C/min / 210.20 °F/min
Power in W	1300	3200
Lift function	No	Yes
Speedsintering	No	Yes

# Suction system

## iVAC silent & iVAC silent PRO

The system is equipped with a teflon filter cartridge, automatic filter cleaning and a dust drawer. With the suction power of 160m<sup>3</sup>/h the iVAC silent is perfectly suited for your CORITEC 150i and is even stowable in the optional machine table.



	iVAC silent	iVAC silent PRO
airflow	160 m <sup>3</sup> /hr	240 m <sup>3</sup> /hr
power	490 W	1610 W
filter system	Teflon filter cartridge, automatic cleaning feature	Teflon filter cartridge, automatic cleaning feature
filter volume	8 liters/30.28 gpm (dust drawer)	8 liters/30.28 gpm (dust drawer)
width x depth x height	9.6 x 19.6 x 17.3 inch / 245 x 500 x 440 mm	10.6 x 21.2 x 21.1 inch / 270 x 540 x 535 mm
supply voltage	230 V	115 V/230 V
special features	suitable for machine tables T0, T1 and T2, quiet running, very compact, self-cleaning by vibration	suitable for machine tables T1 and T2, quiet running, very compact, self-cleaning by vibration



# Machine table

## MACHINE TABLE T0

The machine table T0 is exactly adapted to the CORITEC 150i series by its dimensions 422 x 540 x 900 mm / 16.6 x 21.3 x 35.4 inch (W x D x H).

# Dimensions

## CORiTEC 150i series

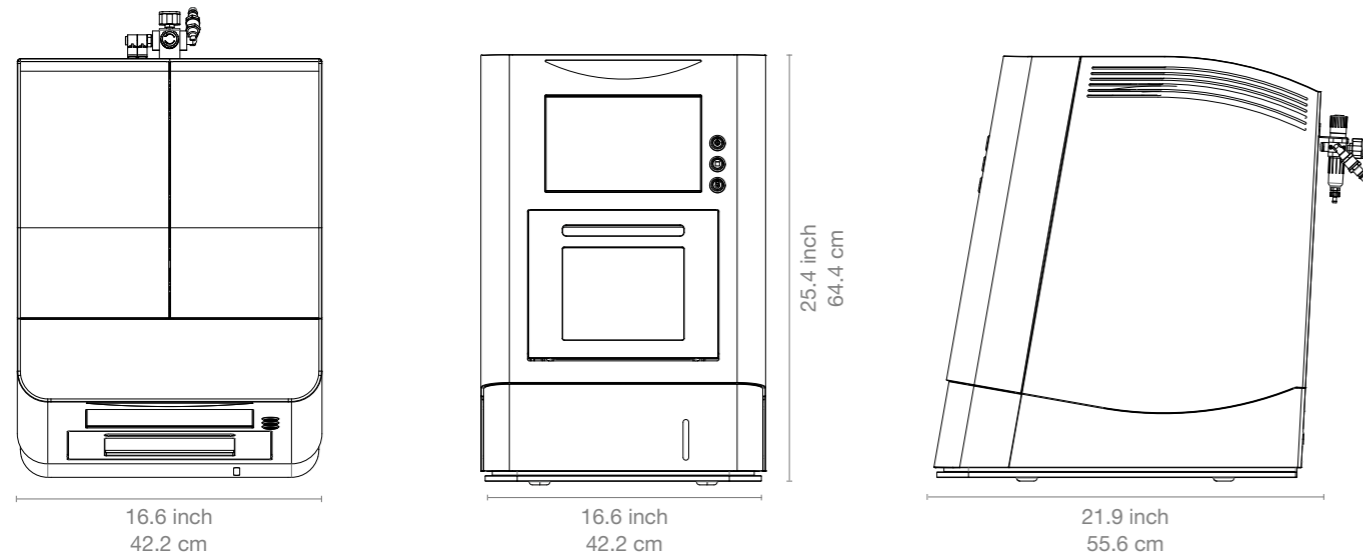

## Machine table T0

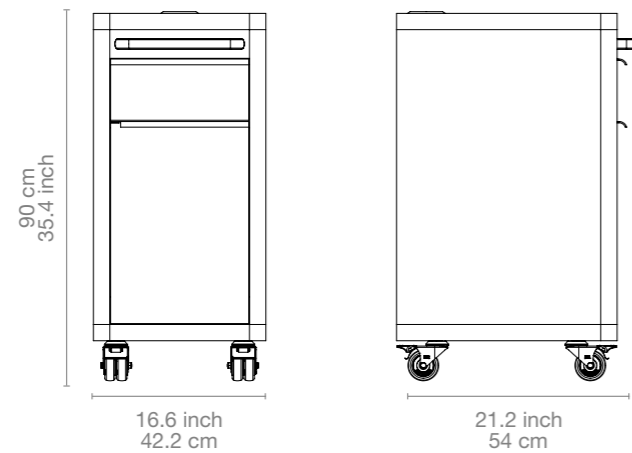

# In numbers

mechanics/electronics	
number of axes and operation type	5 axes, simultaneous processing
rotation angle	A-axis 360°, B-axis 130°
spindle / power	high-frequency spindle / 750 W
maximum spindle speed	100.000 rpm
tools	milling and grinding tools with 3 mm tool shaft
tool changer	10-fold
tool length control	≤ 0.002 mm precision
integrated PC	Windows based
monitor	integrated 10"1" touchscreen (CORiTEC 150i dry & 150i PRO)
illumination	3 LED status colors
software	SmartControl™ integrated CNC software
air pressure	3 bar/43.5 PSI, 50l/min/189.25 gpm/min
cooling liquid	3 liter/11.36 gpm integrated
connecting requirements	
weight	75 kg / 165.38 lbs
width x depth x height	16.6 x 21.9 x 25.4 inch / 422 x 556 x 644 mm
line voltage/frequency	100 V - 240 V/50/60 Hz

# Sales and support partner worldwide



Represented for you in over 100 countries.

imes-icore® GmbH has been a leading manufacturer and technology partner since 2003 in the field of dental CAD/CAM systems and solutions.

With its unique range of dental milling and grinding systems, imes-icore® offers a perfect selection for all individual requirements of dental laboratories, milling centres and dental practices of all sizes.

Our “Open-System” product philosophy makes it possible to easily integrate our milling machines into your existing workflow and to integrate them with your open scanners and your CAD/CAM software. We are open for your material selection.

**imes-icore® GmbH**

Fon +49 (0) 66 72/898 228

Fax +49 (0) 66 72/898 222

dental@imes-icore.de